

**Version : 1**

TECHNICAL SPECIFICATION

MODEL NO. : PD050VX4

The content of this information is subject to be changed without notice.  
Please contact PVI or its agent for further information.

Customer's Confirmation

---

**FOR MORE INFORMATION:**

AZ DISPLAYS, INC.  
75 COLUMBIA, ALISO VIEJO, CA, 92656  
[Http://www.AZDISPLAYS.com](http://www.AZDISPLAYS.com)





# TECHNICAL SPECIFICATION

## CONTENTS

<b>NO.</b>	<b>ITEM</b>	<b>PAGE</b>
-	Cover	1
-	Contents	2
1	Application	3
2	Features	3
3	Mechanical Specifications	3
4	Mechanical Drawing of TFT-LCD module	4
5	Input / Output Terminals	6
6	Absolute Maximum Ratings	10
7	Electrical Characteristics	10
8	Pixel Arrangement	12
9	Display Color and Gray Scale Reference	13
10	Block Diagram	14
11	Interface Timing	15
12	Power On Sequence	20
13	Optical Characteristics	20
14	Handling Cautions	24
15	Reliability Test	25
16	Packing Diagram	26
-	Revision History	27

## 1. Application

This data sheet applies to a color TFT LCD module, PD050VX4.

This module applies to OA product, computer peripheral, industrial meter, image communication and multi-media. If you must use in severe reliability environment, please don't extend over PVI's reliability test conditions.

If you use PD050VX4, Prime View advises your systems use PVI's timing controller IC (PVI-2003A) which will generate proper timing signals to control it.

## 2. Features

- . VGA (640\*480 pixels) resolution
- . Amorphous silicon TFT LCD panel with back-light unit
- . Pixel in stripe configuration
- . Thin and light weight
- . Display Colors : 262,144 colors
- . Optimum Viewing Direction : 3 o'clock
- . Portrait mode
- . TTL transmission interface

## 3. Mechanical Specifications

Parameter	Specifications	Unit
Screen Size	5.0(diagonal)	inch
Display Format	640(H)×(R, G, B)×480(V)	dot
Display Colors	262,144	
Active Area	74.88 (H)×101.76(V)	mm
Pixel Pitch	0.156(H)×0.159(V)	mm
Pixel Configuration	Stripe	
Surface Treatment	AG+SWV	
Outline Dimension	91.4(H)×119.3 (V)×7.9(D)	mm
Weight	120±10	g
Back-light	CCFL, 1 tube	
Display mode	Normally white	
Gray scale inversion direction	3 o'clock	



Outline Drawing : Rear View (unit : mm)

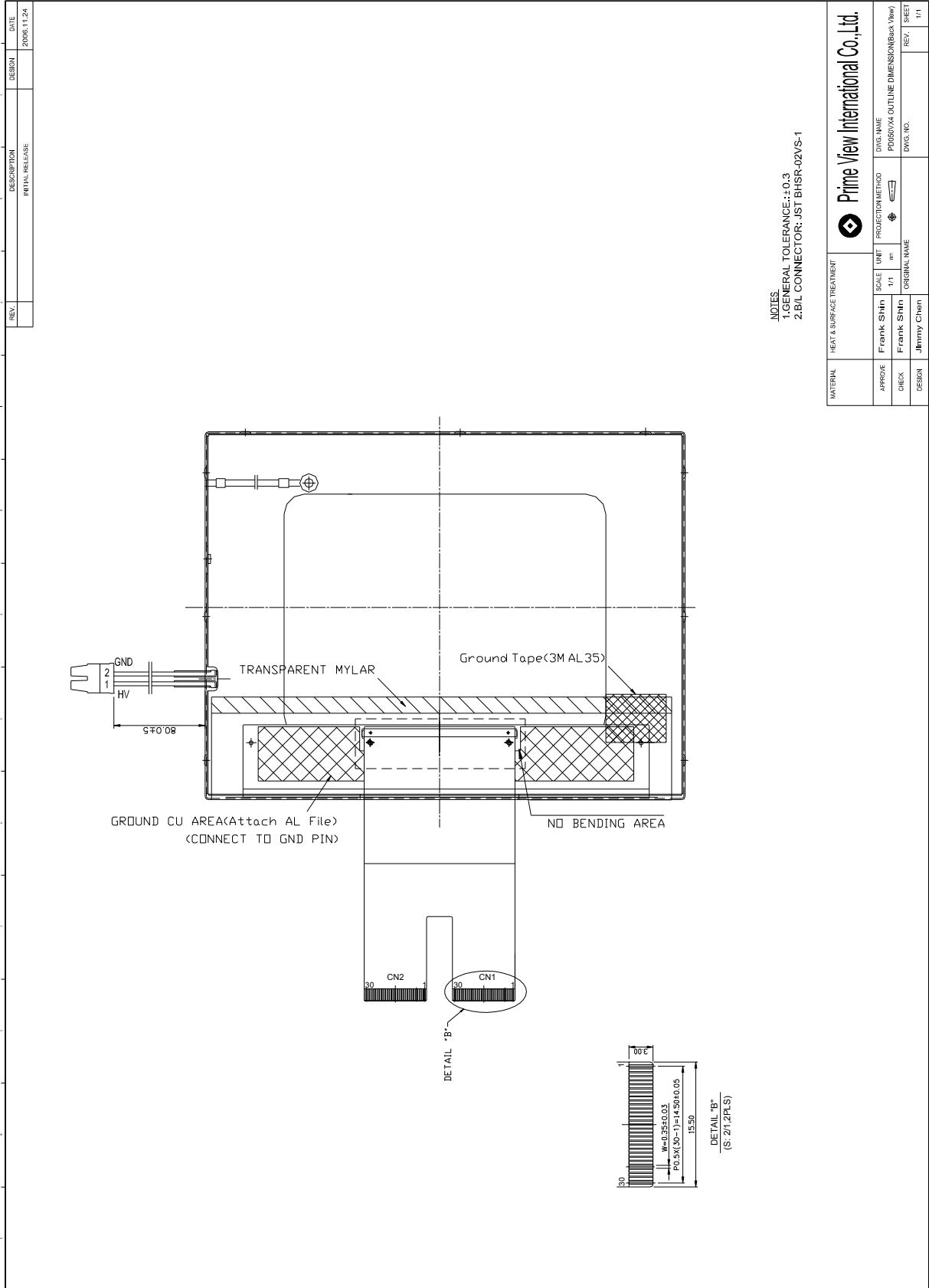

## 5. Input / Output Terminals

### 5-1) TFT-LCD Panel Driving

#### CN 1

LCD Module Connector  
 FPC Down Connect , 30 Pins , Pitch : 0.5 mm

Pin No.	Symbol	I/O	Function	Remark
1	DIO1	I/O	Horizontal Start Pulse Signal Input or Output	Note 5-6
2	VSS1	I	Ground	
3	VDD1	I	Power Supply for Source	
4	CLK	I	Horizontal Shift Clock	
5	VSS1	I	Ground	
6	R/L	I	Right/Left selection	Note 5-6
7	R0	I	Red Data (LSB)	
8	R1	I	Red Data	
9	R2	I	Red Data	
10	R3	I	Red Data	
11	R4	I	Red Data	
12	R5	I	Red Data (MSB)	
13	VSS1	I	Ground	
14	G0	I	Green Data (LSB)	
15	G1	I	Green Data	
16	G2	I	Green Data	
17	G3	I	Green Data	
18	G4	I	Green Data	
19	G5	I	Green Data (MSB)	
20	VSS1	I	Ground	
21	B0	I	Blue Data (LSB)	
22	B1	I	Blue Data	
23	B2	I	Blue Data	
24	B3	I	Blue Data	
25	B4	I	Blue Data	
26	B5	I	Blue Data (MSB)	
27	LD	I	Load output signal	Note 5-7
28	REV	I	Data invert control	Note 5-8
29	POL	I	Polarity selection	Note 5-9
30	DIO2	I/O	Horizontal Start Pulse Signal Input or Output	Note 5-6

CN 2

Pin No.	Symbol	I/O	Function	Remark
1	VSS2	I	Ground	
2	V1	I	Gamma Voltage 1	Note 5-10
3	V2	I	Gamma Voltage 2	Note 5-10
4	V3	I	Gamma Voltage 3	Note 5-10
5	V4	I	Gamma Voltage 4	Note 5-10
6	V5	I	Gamma Voltage 5	Note 5-10
7	V6	I	Gamma Voltage 6	Note 5-10
8	V7	I	Gamma Voltage 7	Note 5-10
9	VSS2	I	Ground	
10	V8	I	Gamma Voltage 8	Note 5-10
11	V9	I	Gamma Voltage 9	Note 5-10
12	V10	I	Gamma Voltage 10	Note 5-10
13	V11	I	Gamma Voltage 11	Note 5-10
14	V12	I	Gamma Voltage 12	Note 5-10
15	V13	I	Gamma Voltage 13	Note 5-10
16	V14	I	Gamma Voltage 14	Note 5-10
17	VSS2	I	Ground	
18	VDD2	I	Voltage for analog circuit	Note 5-10
19	VCOM	I	Common Voltage	
20	XON	I	NC	
21	OE	I	Output Enable	Note 5-5
22	U/D	I	Up/Down selection	Note 5-3
23	CKV	I	Vertical Shift Clock	Note 5-4
24	STVU	I/O	Vertical Shift Pulse Signal Input or Output	Note 5-3
25	STVD	I/O	Vertical Shift Pulse Signal Input or Output	Note 5-3
26	VGG	I	Gate On Voltage	Note 5-2
27	GND	I	Ground	
28	VCC	I	Voltage for logic circuit	
29	GND	I	Ground	
30	VEE	I	Gate Off Voltage	Note 5-1

Note 5-1: Gate off voltage,  $V_{EE}=-5.5V$

Note 5-2: Gate on voltage,  $V_{GG}=+15.4V$

Note 5-3: Select up or down shift

U/D	STVU	STVD	Shift
1	Hi-Z	Input	Down to Up
0	Input	Hi-Z	Up to Down

Note 5-4: Gate driver shift clock

Note 5-5: When OE is connected to high "1", the driver outputs are disabled (Gate output =  $V_{EE}$ ). Under this condition, the operation of registers will not be affected.

Note 5-6: Select left or right shift

R/L	DIO1	DIO2	Shift
1	Input	Hi-Z	Left to right
0	Hi-Z	Input	Right to left

Note 5-7: Latch the polarity of outputs and switch the new data to outputs. At the rising edge (LD), latch the "POL" signal to control the polarity of the outputs.

Note 5-8: Control whether the Data R0~G5 are inverted or not. (PVI suggests connecting to GND) When "REV=1", these data will be inverted.  
EX: "00"→"3F", "07"→"38", "15"→"2A"

Note 5-9: Polarity selector for dot-inversion control. Available at the rising edge of LD.  
When POL=1: Even outputs range from V1~V7, and Odd outputs range from V8~V14; When POL=0: Even outputs range from V8~V14, and Odd outputs range from V1~V7.



Note 5-10:  $V_{DD2} = +7.7V$

Typical Application Circuit (When  $V_1 = +7.7V$ )

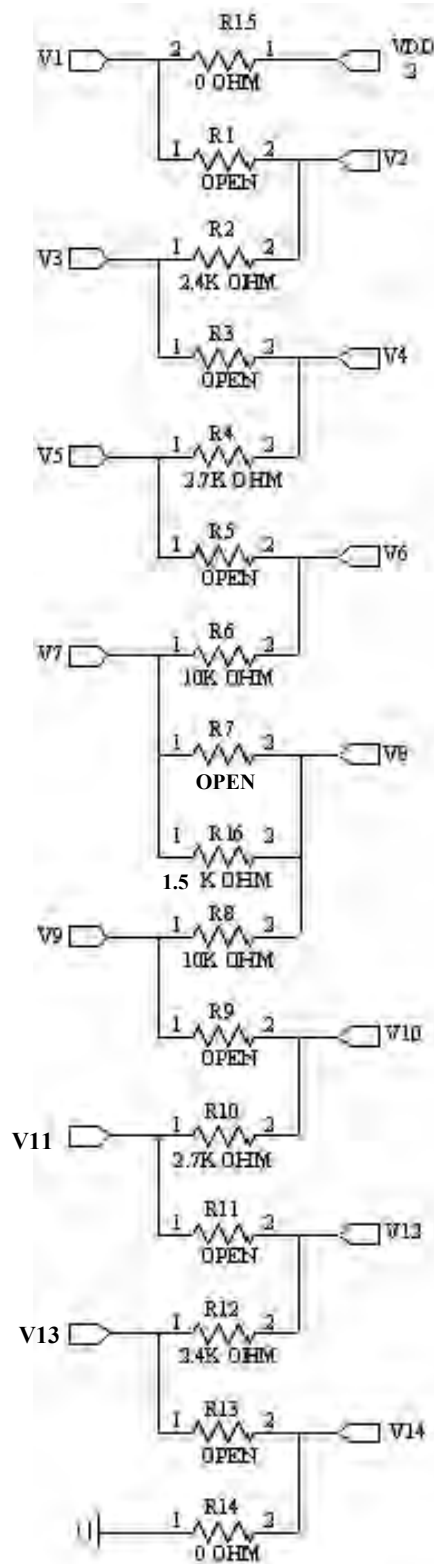

**5-2) Backlight driving**

Connector type: JST BHSR-02VS-1, 2Pins, Pitch : 4 mm

Pin No	Symbol	Description	Remark
1	VL1	Input terminal (Hi voltage side)	Wire Color : Pink
2	VL2	Input terminal (Low voltage side)	Wire Color : White Note 5-11

Note 5-11 : Low voltage side of backlight inverter connects with ground of inverter circuits.

**6. Absolute Maximum Ratings:**

$V_{SS1}=V_{SS2}=GND=0V, Ta=25^{\circ}C$

Parameters	Symbol	MIN.	MAX.	Unit	Remark
Supply Voltage	$V_{DD1}$	-0.5	5.0	V	
	$V_{CC}$	-0.3	6.0	V	
	$V_{DD2}$	-0.5	12.0	V	
	$V_{GG}$	-0.3	40.0	V	
	$V_{GG}-V_{EE}$	-0.3	40.0	V	
	$V_{EE}$	-20	0.3	V	

**7. Electrical Characteristics**

**7-1) Recommended Operating Conditions:**

$V_{SS1}=V_{SS2}=GND=0V, Ta=25^{\circ}C$

Item	Symbol	Min.	Typ.	Max.	Unit	Remark
Supply Voltage for Source Driver	$V_{DD1}$	2.3	3.3	3.6	V	
	$V_{DD2}$	6.5	7.7	13.5	V	
Supply Voltage for Gate Driver	$V_{GG}$	14.4	15.4	16.4	V	
	$V_{EE}$	-6.0	-5.5	-5.0	V	
	$V_{CC}$	2.3	3.3	5.5	V	
$V_{com}$ Voltage	$V_{com}$	-	2.6	-	V	
Digital Input Voltage	$V_{IH}$	$0.7 V_{CC}$	-	$V_{CC}$	V	
	$V_{IL}$	0	-	$0.3 V_{CC}$	V	

**7-2) Recommended Driving Condition for Back Light**

Ta=25°C

Parameter	Symbol	Min.	Typ.	Max.	Unit	Remark
Lamp Voltage	$V_L$	390	410	430	V	$I_L=6mA$
Lamp Current	$I_L$	4.0	6.0	8.0	mA	Note 7-1
Lamp Frequency	$P_L$	30	45	60	KHz	Note 7-2
Starting Voltage (25°C) (Reference Value)	$V_s$	-	-	640	Vrms	Note 7-3
Starting Voltage (0°C) (Reference Value)	$V_s$	-	-	740	Vrms	Note 7-3

Note 7-1: In order to satisfy the quality of B/L, no matter use what kind of inverter, the output lamp current must between Min. and Max. to avoid the abnormal display image caused by B/L.

Note 7-2: The waveform of lamp driving voltage should be as closed to a perfect sine wave as possible.

Note 7-3: The "Max of starting voltage" means the minimum voltage of inverter to turn on the CCFL and it should be applied to the lamp for more than 1 second to start up. Otherwise the lamp may not be turned on.

**7-3) Power Consumption**

Parameter	Symbol	Condition	Typ.	Max.	Unit	Remark
Supply Current for Gate Driver (Hi level)	$I_{GG}$	$V_{GG}=+15.4V$	0.090	0.100	mA	
Supply Current for Gate Driver (Low level)	$I_{EE}$	$V_{EE}=-5.5V$	0.103	0.110	mA	
Supply Current for Source Driver (Digital)	$I_{DD1}$	$V_{DD1}=+3.3V$	4.7	5.0	mA	
Supply Current for Source Driver (Analog)	$I_{DD2}$	$V_{DD2}=+7.7V$	17	20	mA	
Supply Current for Gate Driver (Digital)	$I_{CC}$	$V_{CC}=+3.3V$	0.009	0.010	mA	
LCD Panel Power Consumption		-	146.5	155.0	mW	Note 7-4
Back Light Lamp Power Consumption		-	2.46	-	W	Note 7-5

Note 7-4: The power consumption for back light is not included.

Note 7-5: Back light lamp power consumption is calculated by  $I_L \times V_L$ .

**8. Pixel Arrangement**

The LCD module pixel arrangement is the stripe.

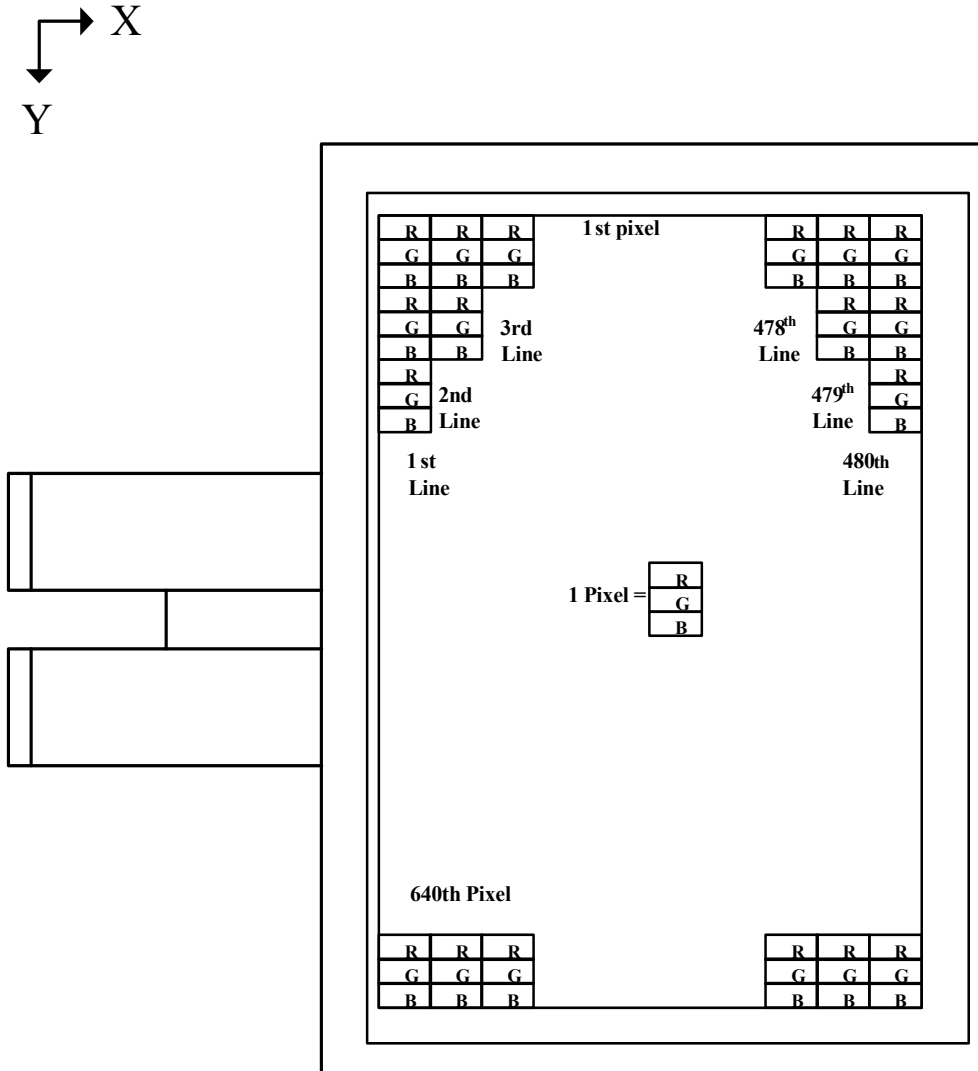

9.Display Color and Gray Scale Reference

Color		Input Color Data																	
		Red						Green						Blue					
		R5	R4	R3	R2	R1	R0	G5	G4	G3	G2	G1	G0	B5	B4	B3	B2	B1	B0
Basic Colors	Black	0	0	0	0	0	0	0	0	0	0	0	0	0	0	0	0	0	0
	Red (63)	1	1	1	1	1	1	0	0	0	0	0	0	0	0	0	0	0	0
	Green (63)	0	0	0	0	0	0	1	1	1	1	1	1	0	0	0	0	0	0
	Blue (63)	0	0	0	0	0	0	0	0	0	0	0	0	1	1	1	1	1	1
	Cyan	0	0	0	0	0	0	1	1	1	1	1	1	1	1	1	1	1	1
	Magenta	1	1	1	1	1	1	0	0	0	0	0	0	1	1	1	1	1	1
	Yellow	1	1	1	1	1	1	1	1	1	1	1	1	0	0	0	0	0	0
	White	1	1	1	1	1	1	1	1	1	1	1	1	1	1	1	1	1	1
Red	Red (00)	0	0	0	0	0	0	0	0	0	0	0	0	0	0	0	0	0	0
	Red (01)	0	0	0	0	0	1	0	0	0	0	0	0	0	0	0	0	0	0
	Red (02)	0	0	0	0	1	0	0	0	0	0	0	0	0	0	0	0	0	0
	Darker																		
	↓	↓	↓	↓	↓	↓	↓	↓	↓	↓	↓	↓	↓	↓	↓	↓	↓	↓	↓
	Brighter																		
	Red (61)	1	1	1	1	0	1	0	0	0	0	0	0	0	0	0	0	0	0
	Red (62)	1	1	1	1	1	0	0	0	0	0	0	0	0	0	0	0	0	0
	Red (63)	1	1	1	1	1	1	0	0	0	0	0	0	0	0	0	0	0	0
Green	Green (00)	0	0	0	0	0	0	0	0	0	0	0	0	0	0	0	0	0	0
	Green (01)	0	0	0	0	0	0	0	0	0	0	0	1	0	0	0	0	0	0
	Green (02)	0	0	0	0	0	0	0	0	0	0	1	0	0	0	0	0	0	0
	Darker																		
	↓	↓	↓	↓	↓	↓	↓	↓	↓	↓	↓	↓	↓	↓	↓	↓	↓	↓	↓
	Brighter																		
	Green (61)	0	0	0	0	0	0	1	1	1	1	0	1	0	0	0	0	0	0
	Green (62)	0	0	0	0	0	0	1	1	1	1	1	0	0	0	0	0	0	0
	Green (63)	0	0	0	0	0	0	1	1	1	1	1	1	0	0	0	0	0	0
Blue	Blue (00)	0	0	0	0	0	0	0	0	0	0	0	0	0	0	0	0	0	0
	Blue (01)	0	0	0	0	0	0	0	0	0	0	0	0	0	0	0	0	0	1
	Blue (02)	0	0	0	0	0	0	0	0	0	0	0	0	0	0	0	0	1	0
	Darker																		
	↓	↓	↓	↓	↓	↓	↓	↓	↓	↓	↓	↓	↓	↓	↓	↓	↓	↓	↓
	Brighter																		
	Blue (61)	0	0	0	0	0	0	0	0	0	0	0	0	1	1	1	1	0	1
	Blue (62)	0	0	0	0	0	0	0	0	0	0	0	0	1	1	1	1	1	0
	Blue (63)	0	0	0	0	0	0	0	0	0	0	0	0	1	1	1	1	1	1

10. Block Diagram

10-1) TFT-module Block Diagram

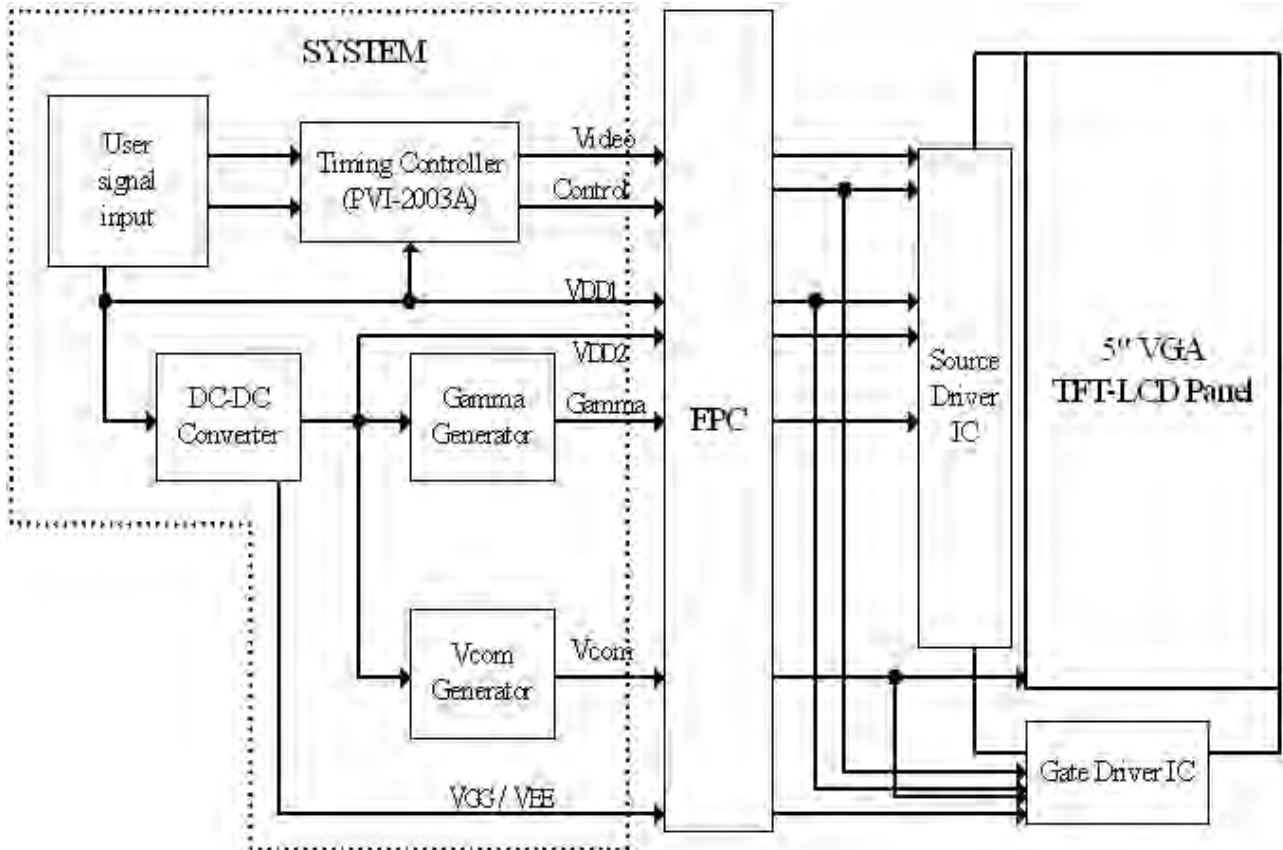

If you use PD050VX4, you can apply PVI-2003A(Timing controller) which will generate timing signals to support PD050VX4.

## 11. Interface Timing

### 11.1) Timing Parameters

AC Electrical Characteristics ( $V_{CC}=V_{DD1}=3.3V$ ,  $V_{DD2}=7.7V$ ,  $GND=V_{SS1}=V_{SS2}=0V$ ,  $T_a=25^{\circ}C$ )

Parameter	Symbol	Min.	Typ.	Max.	Unit
CLK Frequency	Fclk	-	25	40	MHz
CLK Pulse Width	Tcw	25	40	-	ns
Data Set-up Time	Tsu	4	-	-	ns
Data Hold Time	Thd	2	-	-	ns
Propagation Delay of DIO2/1	Tphl	6	10	15	ns
Time That The Last Data to LD	Tld	1	-	-	Tcw
Pulse width of LD	Twld	2	-	-	Tcw
Time That LD to DIO1/2	Tlds	5	-	-	Tcw
POL Set-up Time	Tpsu	6	-	-	ns
POL Hold Time	Tphd	6	-	-	ns
OE Pulse Width	T <sub>OE</sub> V	1	-	-	μs
CKV Pulse Width	T <sub>CKV</sub>	500	-	-	ns
STV Set-up Time	T <sub>SUV</sub>	400	-	-	ns
STV Hold Time	T <sub>HDV</sub>	400	-	-	ns
Horizontal Display Period	T <sub>HDP</sub>	-	640	-	Tcw
Horizontal Period Timing Range	T <sub>HP</sub>	-	800	-	Tcw
Horizontal Lines Per Field	T <sub>V</sub>	520	525	640	T <sub>HP</sub>
Vertical Display Timing Range	T <sub>DV</sub>	-	480	-	T <sub>HP</sub>

**11.2) Timing Diagram**

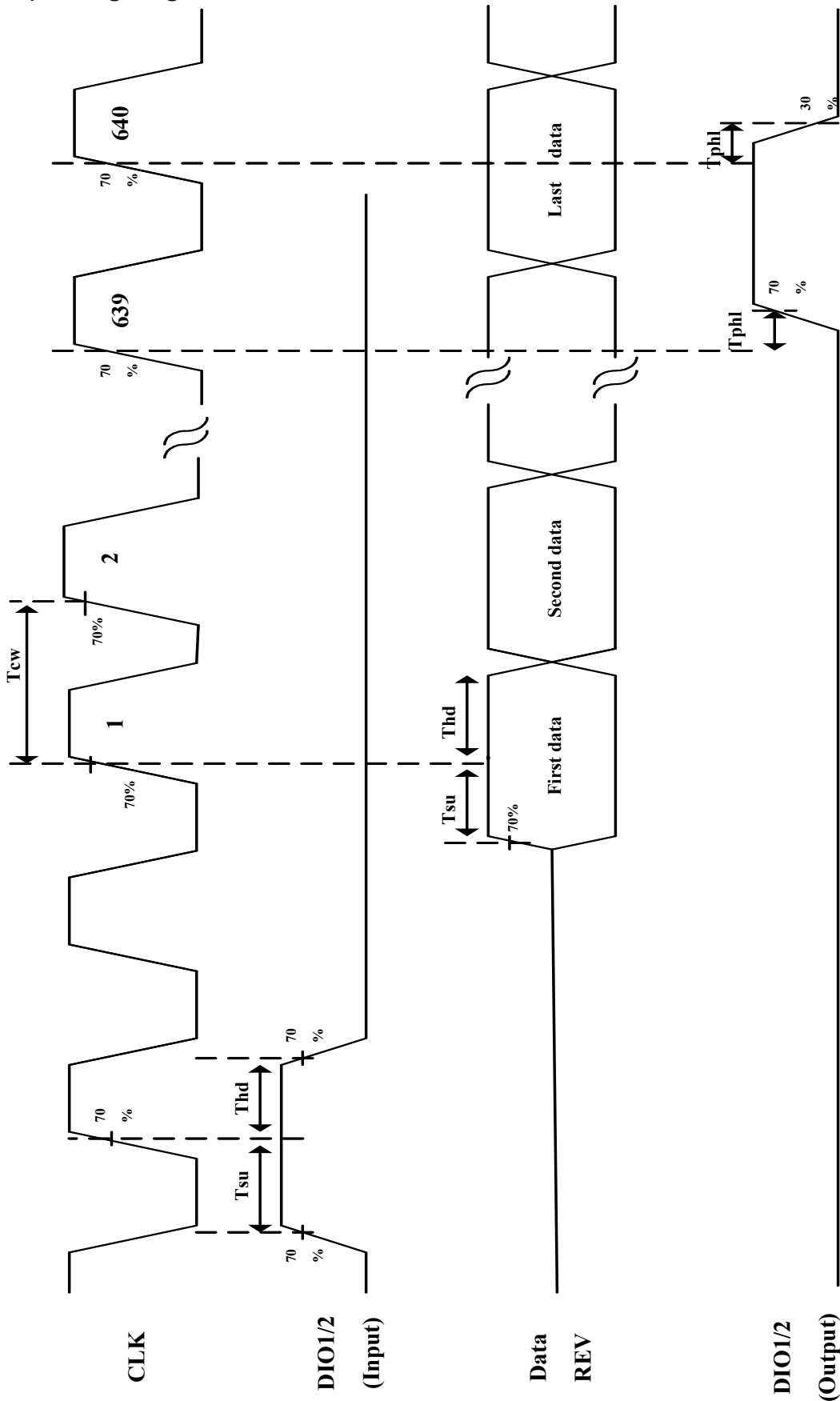

Fig. 11-1 Horizontal timing (1)





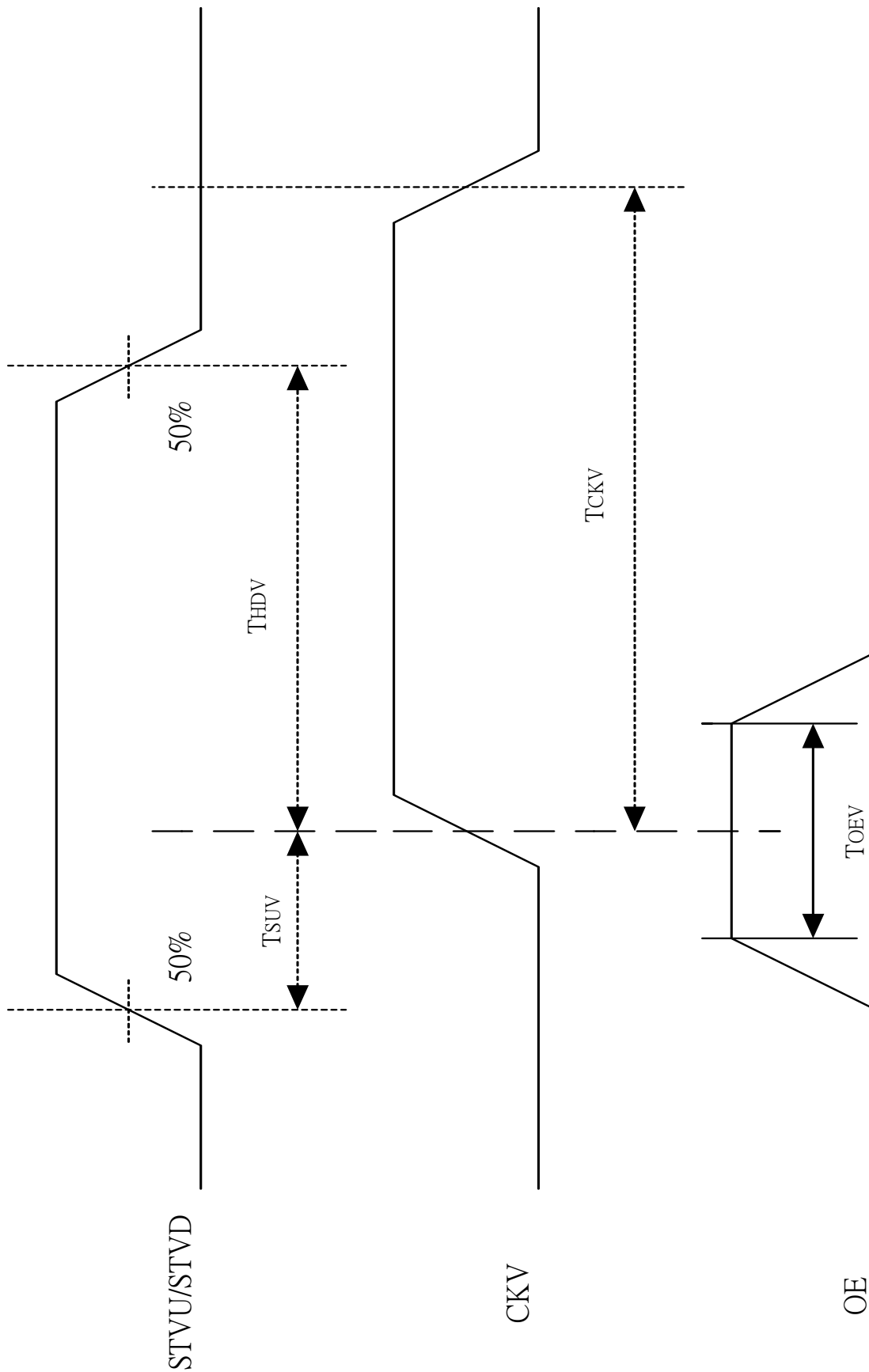

Fig. 11-3 Vertical shift clock timing

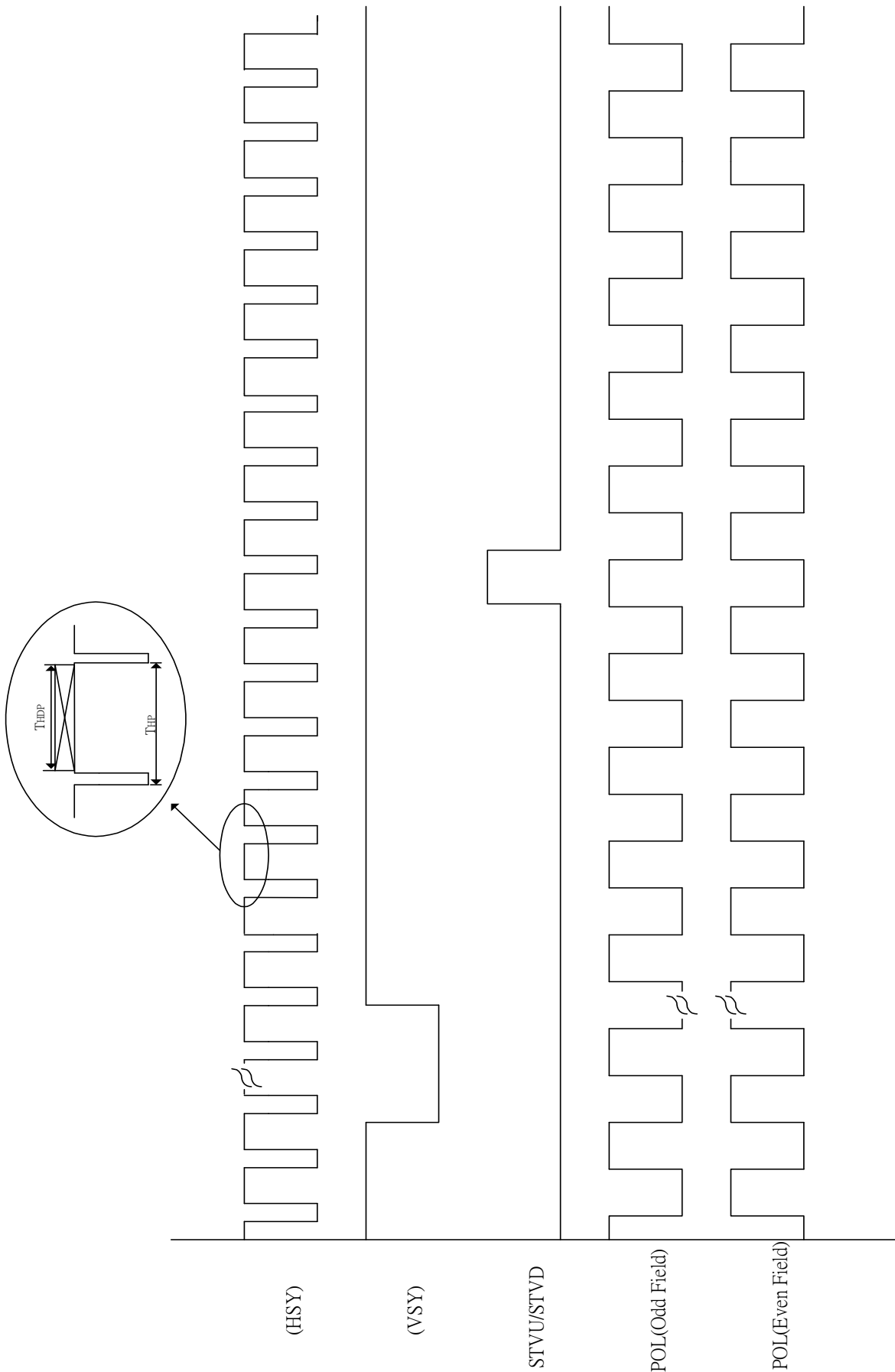
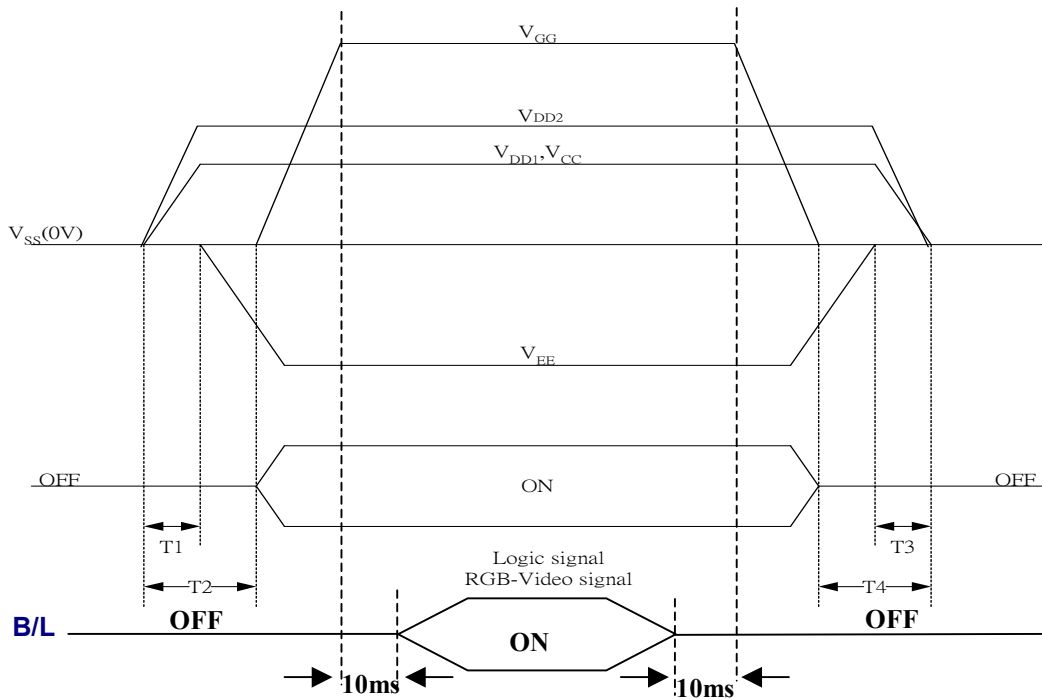

Fig. 11-4 Vertical timing

**12. Power On Sequence**



1.  $10ms \leq T1 < T2$
2.  $0ms < T3 \leq T4 \leq 10ms$

**13. Optical Characteristics**

**13-1) Specification:**

$T_a=25^{\circ}C$

Parameter	Symbol	Condition	MIN.	TYP.	MAX.	Unit	Remarks
Viewing Angle	Vertical	$\theta$ 11,12	55	60	-	deg	Note 13-1
	Horizontal	$\theta$ 22 (3 o'clock)	55	60	-	deg	
		$\theta$ 21 (9 o'clock)	40	45	-	deg	
Contrast Ratio	CR	$CR \geq 10$	200	400	-	-	Note 13-2
Response time	Rise	$T_r$	-	15	30	ms	Note 13-3
	Fall	$T_f$	-	25	50	ms	
Brightness	L	$\theta = 0^{\circ} / \varphi = 0$	300	350	-	cd/m <sup>2</sup>	
Luminance Uniformity	U		70	75	-	%	Note 13-4
Lamp Life Time			50000	-	-	hr	At 6mA
White Chromaticity	x		0.28	0.31	0.34	-	
	y		0.34	0.37	0.40	-	
Cross Talk		$\theta = 0^{\circ}$	-	-	3.5	%	Note 13-5

All the optical measurement shall be executed 30 minutes after backlight being turn-on. The optical characteristics shall be measured in dark room (ambient illumination on panel surface less than 1 Lux). The measuring configuration shows as following figure.

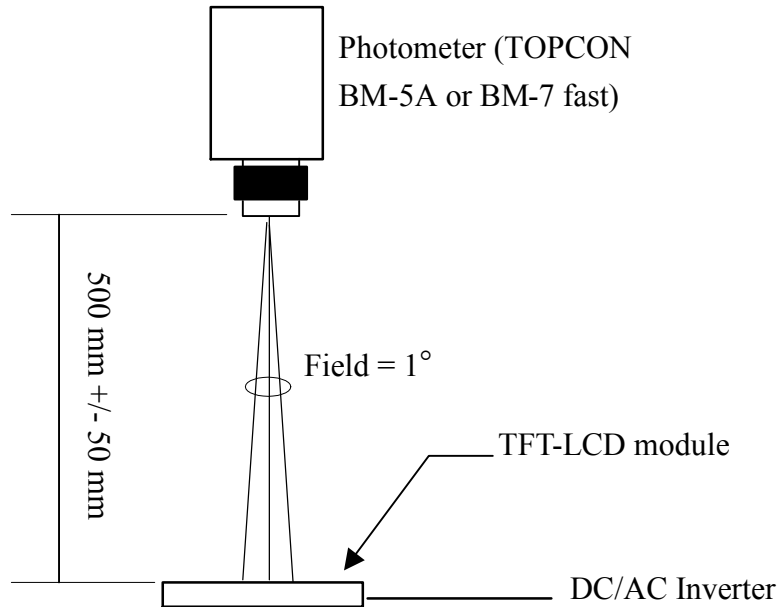

Optical characteristics measuring configuration

Topcon BM-5A or BM-7 fast luminance meter 1° field of view is used in the testing (after 30 minutes' operation). The typical luminance value is measured at lamp current 6.0 mA.

Note 13-1: The definitions of viewing angles are as follow

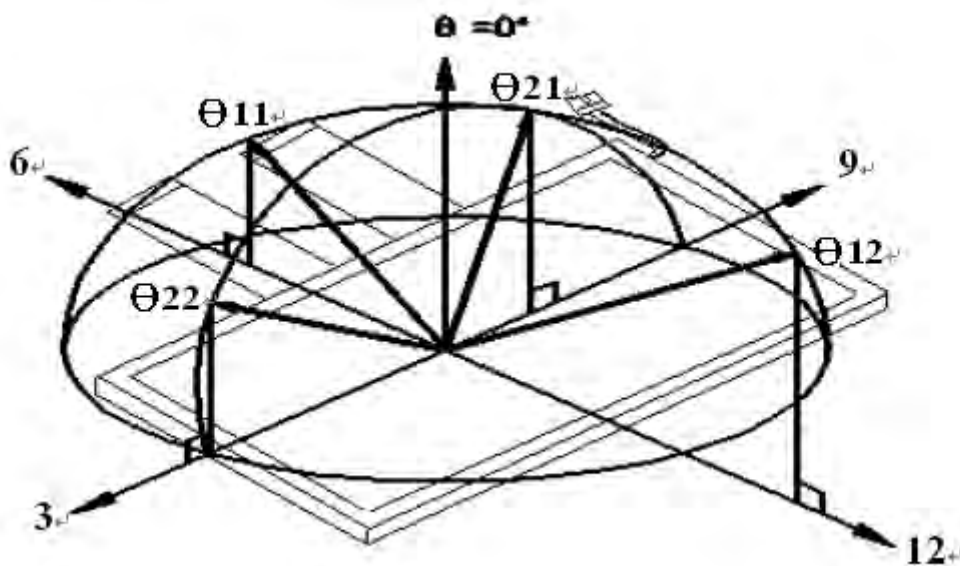

Note 13-2: The definition of contrast ratio  $CR = \frac{\text{Luminance at gray level 63}}{\text{Luminance at gray level 0}}$

Note 13-3: Definition of Response Time  $T_r$  and  $T_f$ :

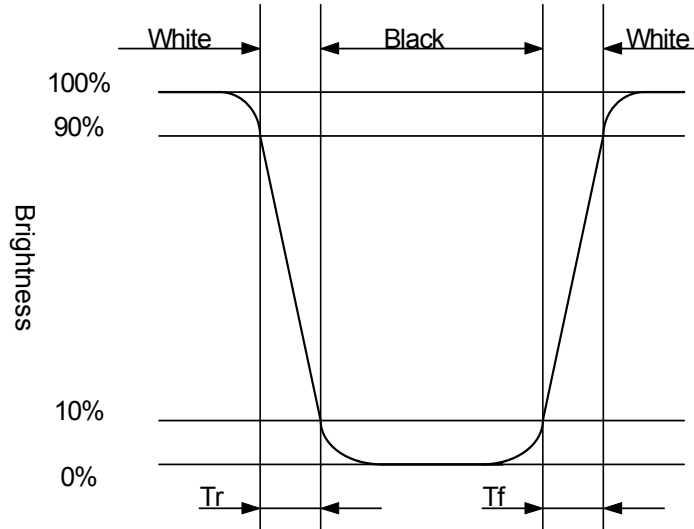

Note 13-4: The uniformity of LCD is defined as

$$U = \frac{\text{The Minimum Brightness of the 9 testing Points}}{\text{The Maximum Brightness of the 9 testing Points}}$$

Luminance meter : BM-5A or BM-7 fast(TOPCON)

Measurement distance : 500 mm +/- 50 mm

Ambient illumination : < 1 Lux

Measuring direction : Perpendicular to the surface of module

The test pattern is white (Gray Level 63).

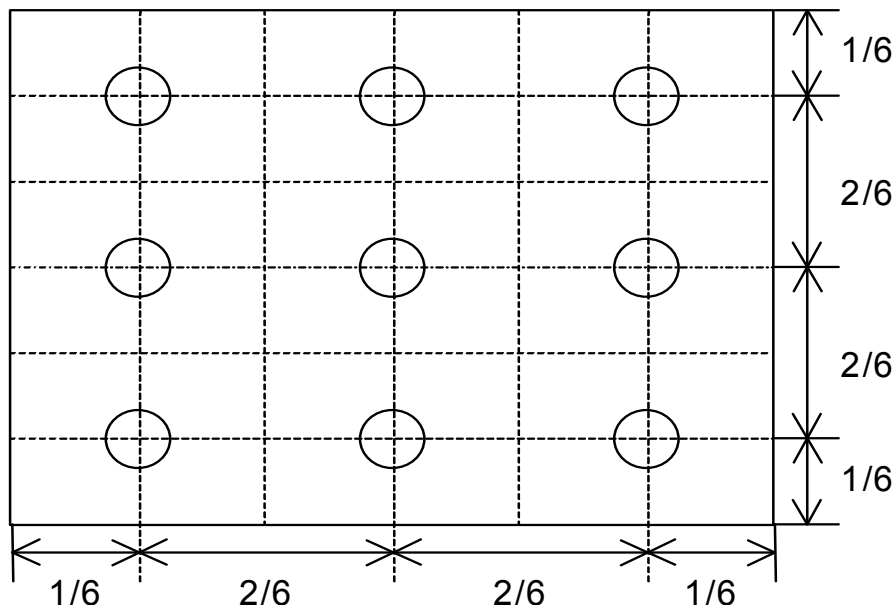

Note 13-5: Cross Talk (CTK) =  $\frac{|YA-YB|}{YA} \times 100\%$

YA: Brightness of Pattern A

YB: Brightness of Pattern B

Luminance meter : BM 5A or BM-7 fast (TOPCON)

Measurement distance : 500 mm +/- 50 mm

Ambient illumination : < 1 Lux

Measuring direction : Perpendicular to the surface of module

Pattern A  
(Gray Level 31)

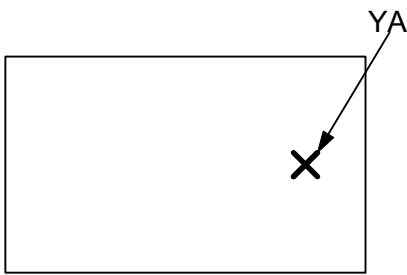

Pattern B  
(Gray Level 31, central black box exclusive)

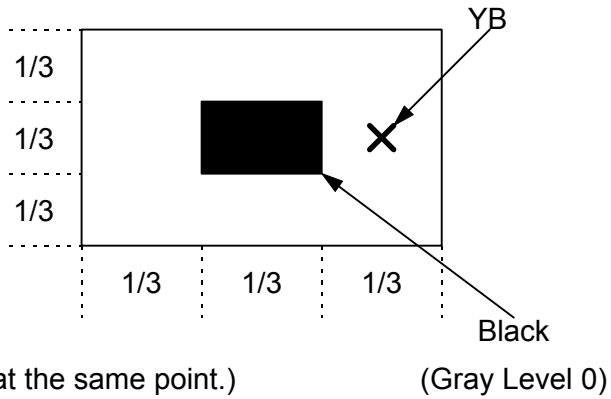

**X**: Measuring Point (A and B are at the same point.)

Black (Gray Level 0)

**14. Handling Cautions****14-1) Mounting of module**

- a) Please power off the module when you connect the input/output connector.
- b) Please connect the ground pattern of the inverter circuit surely. If the connection is not perfect, some following problems may happen possibly.
  - 1.The noise from the backlight unit will increase.
  - 2.The output from inverter circuit will be unstable.
  - 3.In some cases a part of module will heat.
- c) Polarizer which is made of soft material and susceptible to flaw must be handled carefully.
- d) Protective film (Laminator) is applied on surface to protect it against scratches and dirt. It is recommended to peel off the laminator before use and taking care of static electricity.

**14-2) Precautions in mounting**

- a) When metal part of the TFT-LCD module (shielding lid and rear case) is soiled, wipe it with soft dry cloth.
- b) Wipe off water drops or finger grease immediately. Long contact with water may cause discoloration or spots.
- c) TFT-LCD module uses glass which breaks or cracks easily if dropped or bumped on hard surface. Please handle with care.
- d) Since CMOS LSI is used in the module. So take care of static electricity and earth yourself when handling.

**14-3) Adjusting module**

- a) Adjusting volumes on the rear face of the module have been set optimally before shipment.
- b) Therefore, do not change any adjusted values. If adjusted values are changed, the specifications described may not be satisfied.

**14-4) Others**

- a) Do not expose the module to direct sunlight or intensive ultraviolet rays for many hours.
- b) Store the module at a room temperature place.
- c) The voltage of beginning electric discharge may over the normal voltage because of leakage current from approach conductor by to draw lump read lead line around.
- d) If LCD panel breaks, it is possibly that the liquid crystal escapes from the panel. Avoid putting it into eyes or mouth. When liquid crystal sticks on hands, clothes or feet. Wash it out immediately with soap.
- e) Observe all other precautionary requirements in handling general electronic components.
- f) Please adjust the voltage of common electrode as material of attachment by 1 module.



**15. Reliability Test**

No	Test Item	Test Condition	Remark
1	High Temperature Storage Test	Ta = +80°C, 240 hrs	
2	Low Temperature Storage Test	Ta = -30°C, 240hrs	
3	High Temperature Operation Test	Ta = +70°C, 240 hrs	
4	Low Temperature Operation Test	Ta = -20°C, 240hrs	
5	High Temperature & High Humidity Operation Test	Ta = +60°C, 90%RH, 240 hrs (No Condensation)	
6	Thermal Cycling Test (non-operating)	-30°C → +80°C, 100 Cycles 30min 30min	
7	Vibration Test (non-operating)	Frequency : 10 ~ 55 Hz, Amplitude : 1 mm Sweep time: 11 min Test Period: 6 Cycles for each direction of X, Y, Z	
8	Shock Test (non-operating)	100G, 6ms Direction: ±X, ±Y, ±Z Cycle: 3 times	
9	Electrostatic Discharge Test (non-operating)	200pF, 0Ω ±200V 1 time / each terminal	

Ta : ambient temperature

Note : The protective film must be removed before temperature test.

[Criteria]

In the standard conditions, there is not display function NG issue occurred.  
(Including : line defect, no image) All the cosmetic specification is judged before the reliability stress.

**16. Packing Diagram**

ZONE	REV.	DOCUMENT NO.	DESCRIPTION	DATE	REV. BY																									
<p><b>NOTE:</b>                      1. Q'TY: 40 pcs panel/carton.                      2. Dimension: 530*295*230mm                      3. Weight: 8 Kg</p>																														
		<table border="1" style="width:100%; border-collapse: collapse;"> <thead> <tr> <th>ITEM</th> <th>PART NO.</th> <th>DESCRIPTION</th> <th>QTY</th> <th>REMARK</th> </tr> </thead> <tbody> <tr> <td>4</td> <td>50-0100111</td> <td>CARTON</td> <td>1</td> <td></td> </tr> <tr> <td>3</td> <td>50-0500091</td> <td>PINK Bag 195*105mm</td> <td>40</td> <td>抗靜電</td> </tr> <tr> <td>2</td> <td></td> <td>5" Panel</td> <td>40</td> <td></td> </tr> <tr> <td>1</td> <td>50-0300381</td> <td>瓦楞隔板線衝材</td> <td>1</td> <td>上蓋+底座</td> </tr> </tbody> </table>		ITEM	PART NO.	DESCRIPTION	QTY	REMARK	4	50-0100111	CARTON	1		3	50-0500091	PINK Bag 195*105mm	40	抗靜電	2		5" Panel	40		1	50-0300381	瓦楞隔板線衝材	1	上蓋+底座		
ITEM	PART NO.	DESCRIPTION	QTY	REMARK																										
4	50-0100111	CARTON	1																											
3	50-0500091	PINK Bag 195*105mm	40	抗靜電																										
2		5" Panel	40																											
1	50-0300381	瓦楞隔板線衝材	1	上蓋+底座																										
MTL.SPEC.		UNSPECIFIED TOL'S		REMARK																										
		ANGLE																												
		ROUGHNESS																												
APPROVE	Franks	'06.06.19	SCALE	UNIT	SHEET																									
CHECK	Franks	'06.06.19			1 of 1																									
DRAWN	Jimmyc	'06.06.19	MTL.NO.		DWG FILE:																									
					REV. 01																									
					A4 SIZE																									

**元太科技工業股份有限公司**  
 Prime View International Co., Ltd.

**PD050VX4 Packing Draw**

## Revision History

<b>Rev.</b>	<b>Issued Date</b>	<b>Revised</b>	<b>Contents</b>
1.0	Sept. 12, 2006	New	